

Owner's Manual

Vi Tap Dispensing System

VIVREAU[®]
ADVANCED WATER SYSTEMS



Table of contents

Safety Precautions	3
General Information	4
Technical Specifications	5
Pre-installation Requirements	7
Operating Instructions	9
Maintenance	12
Troubleshooting	18

i **IMPORTANT** _____

The information contained in this manual is specific to your system. It is **IMPORTANT** you **READ, FOLLOW** and **UNDERSTAND** the instructions given.

This manual and all material provided with your system should be retained in a convenient location for future reference.

Contact Vivreau if you have any questions regarding the information contained in this manual.

© 2020 Vivreau Water Systems
All rights reserved.
Any and all information contained within this document is subject to change without prior notice.

Safety precautions

i IMPORTANT _____

This manual is intended for use only by personnel trained in the operation of the Vivreau ViTAP Dispensing System.

▲WARNING Improper installation, adjustment, alteration, service or maintenance can cause property damage, injury, or death. Read the installation, operating, and maintenance instructions thoroughly before installing, operating, or maintaining this equipment.

▲WARNING Keep the area around the unit clear of any combustible materials.

▲WARNING Do not store or use gasoline or other flammable vapors or liquids in the vicinity of this or any other unit.

i IMPORTANT _____

Carefully read, understand and follow all safety instructions in this manual and safety labels on the unit.

- Keep safety labels in good condition and replace missing or damaged items.
- Learn how to operate the unit and how to use the controls properly.
- **Do not** let anyone operate the unit without proper training.
- In the event of a power failure, **do not** attempt to operate this unit.
- Keep unit in proper working condition and **do not** allow unauthorized modifications to the unit.

▲WARNING Only trained and certified electrical, plumbing and refrigeration technicians should service this unit.

▲WARNING ALL WIRING AND PLUMBING MUST CONFORM TO NATIONAL AND LOCAL CODES. FAILURE TO COMPLY COULD RESULT IN SERIOUS INJURY, DEATH OR EQUIPMENT DAMAGE.

SAFETY PRECAUTIONS _____

This unit has been specifically designed to provide protection against personal injury.

To ensure continued protection observe the following:

▲WARNING Disconnect power to the unit before servicing. Follow all LOCKOUT/TAGOUT procedures. Verify power to the unit is OFF and disconnected before any work is performed. Failure to do so could result in serious injury, death or equipment damage.

- To protect against electric shock, do not immerse power cord in water or other liquid.
- To prevent damage to the power cord, do not allow cord to hang over the edge of a table or counter, or come in contact with hot surfaces.
- Isolate unit from power supply (unplug or turn OFF breaker) and turn OFF the water supply when not in use and before cleaning.
- Allow Boiler (if supplied) to cool before removing any components.
- The use of spare parts and accessories not recommended by Vivreau may cause damage and/or injuries.
- **Do not** operate any unit with damaged cords, plugs, or after the unit malfunctions or has been damaged in any manner.
- **Do not** use outdoors.
- **Do not** place on or near a hot gas or electric burner.
- **Do not** use the unit for anything other than its intended use.
- **Save these instructions.**

General Information

INFORMATION FOR THE READER

To find specific topics of interest quickly, refer to the Table of Contents at the beginning of this manual.

This manual is solely for the use of personnel trained in the operation of the ViVreau Vi Tap Dispensing System only.

PURPOSE OF THE MANUAL

- Vivreau has produced this manual to provide necessary information to qualified and authorized personnel for the safe and proper installation, operation, and maintenance of the Vivreau Vi tap 2, Vi Tap 2H, Vi Tap 1, and Vi Tap 1H Dispensing Systems.
- Information contained in this manual will help prevent risks to health and safety, and the risk of economic losses.
- Keep this manual in a clearly identified and safe place throughout the working life of the unit, so that it will always be available as needed.
- The manufacturer reserves the right to make modifications to the unit without any obligation to provide prior notice.
- A number of symbols have been used to highlight particularly important parts of the text or important specifications. Their meaning is as defined below.

⚠ DANGER

INDICATES AN IMMINENTLY HAZARDOUS SITUATION WHICH, IF NOT AVOIDED, WILL RESULT IN DEATH OR SERIOUS INJURY.

⚠ WARNING

Indicates that suitable procedures must be adopted to avoid putting people's health and safety at risk or causing economic losses.

⚠ CAUTION

Indicates a potentially hazardous situation which, if not avoided, may result in property damage, minor or moderate injury.

i IMPORTANT _____

Indicates important technical information which must not be overlooked.

Technical Specifications

GENERAL DESCRIPTION

The Vi tap is a self-service water dispensing system designed for under-counter installation with the dispenser head mounted to the countertop directly above the unit.

The system is made up of several components (depending on model) that will fit under a standard base-cabinet section that is 30" wide (min.)

Dispensing Specifications					
Description	Specification	ViTap-2	ViTap-2H	ViTap-1	ViTap-1H
Chilled still water	$\Delta T=18\text{ }^{\circ}\text{F @ 15.8 gal/h}$	✓	✓	✓	✓
Chilled sparkling water	$\Delta T=18\text{ }^{\circ}\text{F @ 15.8 gal/h}$	✓	✓	NA	NA
Hot water	203°F	NA	✓	NA	✓
Hot water, immediate dispense	0.5 gal/h	NA	✓	NA	✓
Hot water, storage capacity	1.2 gal.	NA	✓	NA	✓
Water Pressure at Dispensing Head	5 PSI	✓	✓	✓	✓

Operating Conditions					
Description	Specification	ViTap-2	ViTap-2H	ViTap-1	ViTap-1H
Temperature	60 – 90°F	✓	✓	✓	✓
Relative Humidity	60% (max.)	✓	✓	✓	✓

Water Supply Requirements					
Description	Requirements	ViTap-2	ViTap-2H	ViTap-1	ViTap-1H
FNPT connection with Ball Valve	1/2"	✓	✓	✓	✓
PSI (min.)	50	✓	✓	✓	✓
GPH (min.)	80	✓	✓	✓	✓
Temperature (max.)	60°F	✓	✓	✓	✓

CO ₂ Operating Pressure					
Description	Requirements	ViTap-2	ViTap-2H	ViTap-1	ViTap-1H
Pressure	65 – 70 PSI	✓	✓	NA	NA
Supply pressure (Bulk System)	100 PSI (min.)	✓	✓	NA	NA

Dispensing Head Specifications					
Description	Requirements	ViTap-2	ViTap-2H	ViTap-1	ViTap-1H
Height	13"	✓	✓	✓	✓
Distance Nozzle to Drip Tray	9.6"	✓	✓	✓	✓
Weight	7.4 lb	✓	✓	✓	✓

Cooler/Carbonator Specifications

Description	Specification	ViTap-2	ViTap-2H	ViTap-1	ViTap-1H
Width	15"	✓	✓	8.25"	8.25"
Height	20"	✓	✓	19"	19"
Depth	18.5"	✓	✓	14"	14"
Weight	39.6 lb.	✓	✓	44.6 lb	44.6 lb
Voltage	110/120 VAC/60 Hz	✓	✓	✓	✓
Amperage	11A	✓	✓	✓	✓

Boiler Specifications

Description	Specification	ViTap-2	ViTap-2H	ViTap-1	ViTap-1H
Width	5.25"	NA	✓	NA	5.37"
Height	22"	NA	✓	NA	21"
Depth	15.75"	NA	✓	NA	15.62"
Weight	30.8 lb	NA	✓	NA	18.2 lb
Voltage	110/120 VAC/60 Hz	NA	✓	NA	120 V
	230/240 VAC/60 Hz	NA	NA	NA	240 V
Amperage	13A	NA	✓	NA	✓
	11A	NA	NA	NA	✓

Pre-Installation Requirements

PRE-INSTALLATION

Below are the services required to be in place prior to the installation of the Vivreau ViTAP Dispensing System. If you have any questions regarding these or other services, please contact **Vivreau Service** Toll-Free at 877-999-1044.

WATER SUPPLY

A potable 1/2" cold water supply terminating in a 1/2" Ball Valve, 1/2" female pipe thread.

IMPORTANT _____

Ball Valve must be accessible for service and installation.

Minimum Water Pressure: 50 PSI

Minimum Water Flow: 80 gallons per hour

IMPORTANT _____

The Vivreau ViTAP Dispensing System incorporates backflow prevention. Any additional backflow devices required by State or Local Code must also be supplied by the customer prior to installation. There must not be any other Filters/Pre-Filters inline before the unit.

ELECTRICAL OUTLET

Model ViTAP-2

(1) 20 Amp Electrical Recepticle (NEMA 5-20R)
120V, 60 Hz (11 Amps)

Model ViTAP-2H

(2) 20 Amp Electrical Recepticle (NEMA 5-20R)
120V, 60 Hz (13 Amps & 11 Amps)

Model ViTAP-1

(1) 20 Amp Electrical Recepticle (NEMA 5-20R)
120V, 60 Hz (11 Amps)

Model ViTAP-1H

(2) 20 Amp Electrical Recepticle (NEMA 5-20R)
120V, 60 Hz (13 Amps & 11 Amps) .

All outlets **must be** mounted high in the cabinet to avoid accidental contact with water.

CO₂ (Vi2 and Vi2H)

CO₂ Cylinder (Customer supplied) - Size should be selected based on available space.

NOTE: If connecting to a bulk or existing CO₂ system, a CO₂ line terminating at a 1/4" Barbed Shutoff Valve must be available within 40" of the unit with 100 PSI minimum pressure.

DRIP TRAY AND DISPENSING HEAD CUTOUTS

Cut out the holes for the Drip Tray and Dispensing Head per the supplied template.

NOTE: The Dispensing Head must be mounted on the work surface directly above the Chiller/Carbonator.

DRIP TRAY DRAIN

Drip Tray must be plumbed to a drain. Customer will need to supply a drain according to State and Local Codes. Drain must be at least 1-1/4" ID.

LOCATION OF SERVICES

All services must be accessible for installation and service. Ensure all services are kept within 40" of the ViTAP Dispensing System.

Water Shutoff Valve to be located at low level. Ensure there is sufficient room for a 6" long fitting to be connected to the Water Shutoff Valve.

Top of drain should be located between 12" and 18" from floor level.

LOCATION

A suitable location should be chosen within 40" of the electrical and water supply connections.

Installation Clearance for Chiller Unit	
Left side	2"
Right side	2"
Rear	2"
Above	Open

Do not obstruct air vents.

Install the system on a firm, level floor or base.

VENTILATION

If the system is to be installed in an enclosed space or in a cabinet, adequate ventilation must be provided. Ventilation must be at the top and bottom of the enclosure for proper air flow.

CAUTION Failure to provide adequate ventilation will cause system failure.

This unit is to be installed indoors only.

DISPENSING HEAD

The Dispensing Head with Integral Drip Tray is installed into a countertop directly over the Chiller/Carbonator and Boiler (if equipped) using the supplied template.

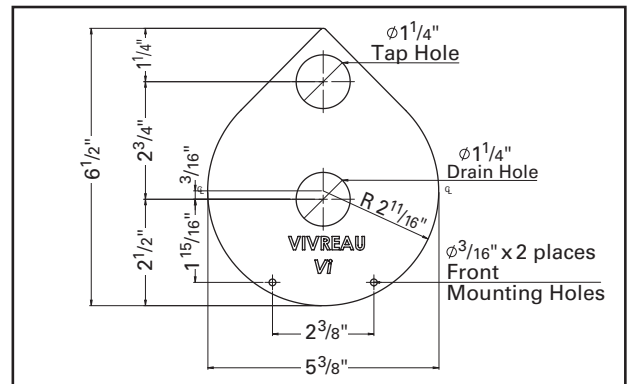

Dispensing Head Template

PLEASE NOTE
All vents must open to fresh air in a free and unobstructed area

24 square inches of opening is required for each of the top and bottom vents.
48 square inches in total

4). Countertop cutout can be used as a top ventilation option

1). Front Ventilation
Showing Ventilation grilles cut in a standard door panel

2). Base Cutout
Ventilation can be made to the base of the cabinet, with the removal of a narrow section of floor, immediately behind the door and trim with roll edging strip. Typical cut-out size must not be less than 12.0" wide x 2" deep (24 sq inch)

3). Side Ventilation
Ventilation grilles cut in the side of a standard cabinet. The grilles may be fitted on either side.
Does not open into an enclosed cabinet.

Cut-out detail for the available 12" VIVREAU grill, shown in a 23.5" (24") wide door

OPTIONAL
Available VIVREAU Grill

The cabinet may be ventilated in several different ways to prevent excessive heat build up. The methods shown all take advantage of natural circulation by placing two grilles or cut-outs; one near the base and the other at the top of the enclosure.

Ventilation Options

Operating Instructions

The ViTAP Dispensing System has been designed for ease of use.

i IMPORTANT _____

Before operating the ViTAP Dispensing System, make sure the water supply is turned ON and the unit is plugged in.

BEFORE USE

ALWAYS sanitize your hands.

ALWAYS wear hygienic gloves.

ALWAYS remove anti-bacterial cling film from the Dispensing Head.

ALWAYS wipe Dispensing Head, Nozzles, Drip Tray and cabinet work-surface with anti-bacterial wipes.

LED DISPLAY PANEL

The LED Display Panel is located on the front panel of the Chiller/Carbonator.

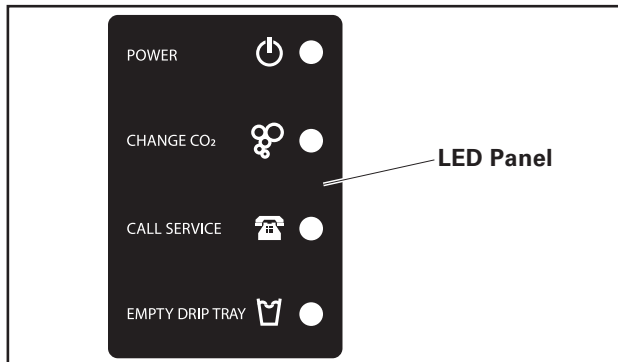

Dispensing Head System LED Display Panel

POWER: When the Dispensing Head System is plugged in and turned ON, a Blue LED will be illuminated.

CHANGE CO₂: When the CO₂ supply is low, a Red LED will illuminate and the unit will beep; alerting you to change the CO₂ Cylinder.

CALL SERVICE: If there is a problem, a Red LED will illuminate and the unit will beep. Please contact **Vivreau Service** Toll-Free at 877-999-1044 immediately.

EMPTY DRIP TRAY: (Not Activated on this Unit): When the Drip Tray Container is FULL, a Red LED will illuminate and the unit will beep; alerting you to empty the Drip Tray Container located just inside the cabinet front door or below the Dispensing Head System.

DISPENSING

i IMPORTANT _____

Before operating the ViTap Dispensing System, make sure the Water Supply Valve is open and the unit is plugged in.

DISPENSING

Before operating the ViTAP Dispensing System, make sure the Water Supply Valve is open and the Chiller (and Boiler, if supplied) is plugged in.

Place appropriate container on Drip Tray beneath the Dispensing Head.

Chilled Still Water

Press and Hold the Blue Button to dispense water. Release the button when filled.

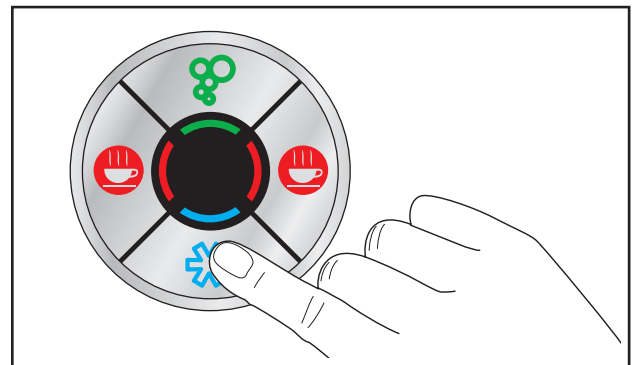

Dispensing Chilled Still Water

Chilled Sparkling Water

Press and Hold the Green Button to dispense water. Release the button when filled.

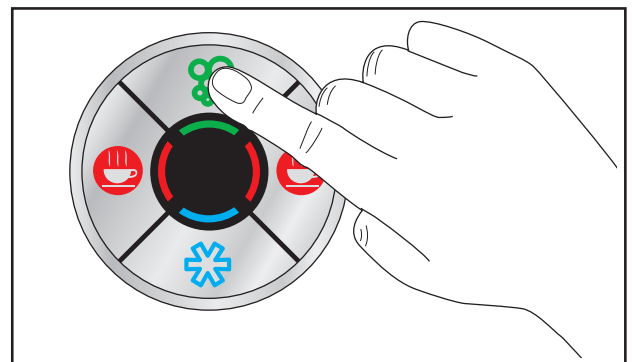

Dispensing Chilled Sparkling Water

DISPENSING

i IMPORTANT

Before operating the ViTap Dispensing System, make sure the Water Supply Valve is open and the unit is plugged in.

Hot Water (if supplied)

As a safety feature, to dispense Hot Water, Touch and Release either Red Button, then Press and Hold the opposite side Red Button within 3 seconds.

Release the button when filled.

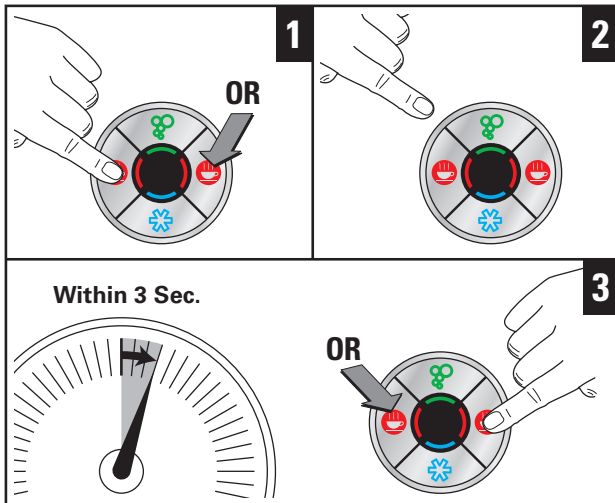

Dispensing Hot Water

⚠ WARNING Water is Hot! Do not place hands or other body parts beneath Dispensing Head when dispensing hot water.

AFTER DAILY USE

Remove Dispensing Nozzle and place in a container of Sanitizing Solution.

Leave Nozzle in Sanitizing Solution for a minimum of 4 hours.

Ensure protective gloves are worn when in contact with Sanitizing Solution.

Wipe Dispensing Head, Drip Tray and countertop surface with anti-bacterial wipes and sanitizing spray.

Wrap Dispensing Head with plastic film.

To return the Dispensing Head System to service, remove the plastic film, rinse Nozzle and install in Dispensing Head.

i IMPORTANT

Ensure the ViTAP Dispensing System and surrounding areas are kept clean and sanitary at all times.

FOR UNITS WITH OPTIONAL HOT WATER BOILER

Operating Boiler for the First Time:

Make sure installation is correct.

Turn ON the Water Supply Valve.

Plug the Boiler in to an appropriate electrical supply and press the Power Button on the front of the unit.

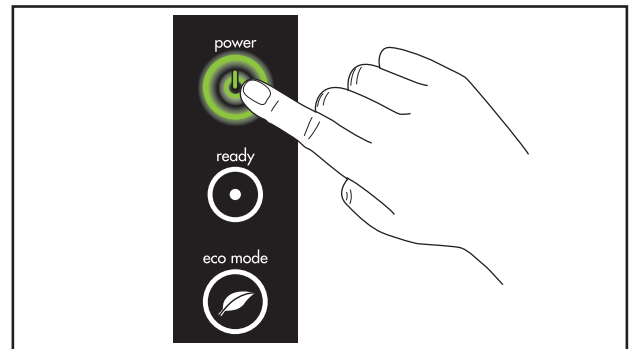

Boiler Start-up

The Power Button will glow green and the unit will fill to a safe level, above the elements, before heating.

i IMPORTANT

Boiler has a Water Level Probe Circuit that must be satisfied before Heating Elements are energized.

The Ready Light will flash 2 times repeatedly as the Tank fills.

When the correct water level is reached, the Controller will energize the Heating Circuit.

Once the water is heated to the preset temperature (203°F), the Boiler will fill until the temperature drops by 1 or 2 degrees. The Boiler will then heat again. This Heat/Fill cycle continues until the Boiler is full.

When the Tank is full but still heating, the Ready Button will remain off. The Ready Button will glow green when the unit is both full and up to normal operating temperature.

The Boiler is now ready for use.

ECO MODE

All Boilers incorporate an ECO Mode function.

To Enable ECO Mode:

Press the ECO Mode Button located below the Ready indicator so that the leaf symbol illuminates green.

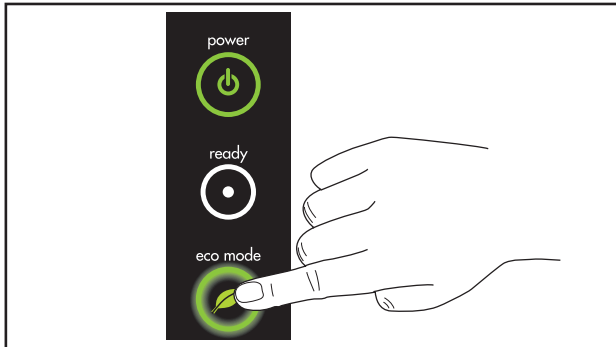

ECO Mode

This mode saves energy by minimizing the energy wasted during unit down-time.

i IMPORTANT _____

ECO Mode is most effective in installations where the unit has a regular OFF period.

To achieve the most benefit from the energy saving ECO Mode on your ECO Boiler unit, follow these procedures:

Towards the end of the Boiler's operating period for a given day, switch the machine to ECO Mode. This will maintain water at 203°F and the unit's Tank will slowly drop to half full.

At the end of the day, the Boiler should be turned Off.

During the Off period, as there is less water in the Tank, there will be less energy lost to the surrounding environment resulting in an energy saving.

To Disable ECO Mode:

Press the ECO Mode Button again. The leaf symbol will no longer be illuminated.

Maintenance

MAINTENANCE RECOMMENDATIONS

Keep the unit at peak efficiency by performing all scheduled maintenance procedures that are recommended by Vivreau. Proper maintenance will allow the best performance and a longer working life.

⚠️ WARNING Before performing any maintenance or service procedure, perform all safety procedures. In particular, turn OFF the water supply, disable the electricity at the main circuit breaker and prevent access to all devices that might cause unexpected health and safety hazards if turned ON.

⚠️ WARNING Before performing any maintenance or service that involves electrical connection or disconnection and/or exposure to electrical components, ALWAYS follow the Electrical LOCKOUT/TAGOUT Procedure. Disconnect all circuits. Failure to comply can cause property damage, injury or death.

At the end of each day or whenever necessary, be sure to clean:

- Dispensing Head/Nozzle
- Drip Tray
- The surrounding work area

Every year, have skilled, authorized personnel perform the following operations:

- General check of the unit
- Identify and replace worn parts

i **IMPORTANT** _____

Record all yearly inspections.

i **IMPORTANT** _____

Contact the factory, the factory representative or an authorized service agent to perform service and repairs.

ELECTRICAL LOCKOUT/TAGOUT PROCEDURE

⚠️ WARNING Before performing any maintenance or service procedure that involves electrical connection or disconnection and/or exposure to electrical components, ALWAYS follow the Electrical LOCKOUT/TAGOUT Procedure. Disconnect all circuits. Failure to comply can cause property damage, injury or death.

The Electrical LOCKOUT/TAGOUT Procedure is used to protect personnel working on an electrical unit. Before performing any maintenance or service that requires exposure to electrical components, follow these steps:

In Electrical Box, place unit Circuit Breaker into OFF position.

Place a lock or other device on the Electrical Box Cover to prevent someone from placing Circuit Breaker in the ON position.

Place a tag on Electrical Box Cover to indicate that unit has been disconnected for service and power should not be restored until tag is removed by maintenance personnel.

Disconnect the unit's Power Cord from Electrical Outlet.

Place a tag on the Power Cord to indicate that the unit has been disconnected for service and power should not be restored until tag is removed by maintenance personnel.

STAINLESS STEEL CARE

Cleaning

Stainless steel contains 70-80% iron, which will rust if not properly maintained. It also contains 12-30% chromium, which forms an invisible passive, protective film that shields against corrosion. If the film remains intact, the stainless steel will remain intact. However, if the film is damaged, the stainless steel can break down and rust. To prevent stainless steel breakdown, follow these steps:

▲ CAUTION Never use any metal tools. Scrapers, files, wire brushes or scouring pads (except for stainless steel scouring pads) will mar the surface.

▲ CAUTION Never use steel wool, which will leave behind particles that rust.

▲ CAUTION Never use acid-based or chloride-containing cleaning solutions, which will break down the protective film.

▲ CAUTION Never rub in a circular motion.

▲ CAUTION Never leave any food products or salt on the surface. Many foods are acidic. Salt contains chloride.

For routine cleaning, use warm water, mild soap or detergent and a sponge or soft cloth.

For heavy-duty cleaning, use warm water, a degreaser and a plastic, stainless steel or Scotch-Brite pad.

Always rinse thoroughly.

Always rub gently in the direction of the steel grain.

Preserving & Restoring

Special stainless steel polishing cleaners can preserve and restore the protective film.

Preserve the life of stainless steel with a regular application of a high quality stainless steel polishing cleaner as a final step to daily cleaning.

If signs of breakdown appear, restore the stainless steel surface. First, thoroughly clean, rinse and dry the surface. Then, on a daily basis, apply a high-quality stainless steel polish according to manufacturer's instructions.

Heat Tint

Darkened areas, called heat tint, may appear on stainless steel exposed to excessive heat, which causes the protective film to thicken. It is unsightly but is not a sign of permanent damage.

To remove heat tint, follow the routine cleaning procedure. Stubborn heat tint will require heavy-duty cleaning.

To reduce heat tint, limit the exposure of equipment to excessive heat.

DAILY CLEANING

The ViTAP Dispensing System should be cleaned once a day.

Vivreau recommends using disinfectant spray or a sanitizing wipe for cleaning.

If the Dispensing Head becomes soiled with coffee, tea, milk etc. clean with hot soapy water using a non-abrasive cloth.

Clean the Drip Tray Cover and inside the Drip Tray using either disinfectant spray (non-chlorine) or hot, soapy water and non-abrasive cloth.

Keep area around the unit clean and sanitized.

ViTAP equipment in the under-counter area should be kept free of dust; the ventilation should not be obstructed restricting free air flow around the equipment.

The ViTAP Nozzle should be removed daily and cleaned with hot soapy water and a non-abrasive cloth.

After completing all cleaning tasks, dispense water for at least 10 seconds to flush through the Nozzle.

Use hot water if the unit is equipped with a Boiler.

DO NOT use any abrasive material on your ViTAP Dispensing System.

CLEANING SCHEDULE

Cleaning Schedule			
Component	Task	Frequency	Personnel
Dispensing Head/Nozzle	Cleaning & Sanitizing	Daily	End-User
Drip Tray	Draining, Cleaning	Daily	End-User
CO₂ Cylinder	Fill Level	Weekly	End-User
	Replace	As Needed	
Chiller Condenser Grille	Cleaning, Degreasing	Weekly	End-User
Chiller Exterior	Cleaning	Weekly	End-User
Water Filter	Replacement	Twice Yearly	Authorized Service Dealer

CLEANING NOZZLE & COVER

The Dispensing Head has a removable Nozzle for ease of cleaning and sanitizing.

⚠️WARNING Wear protective gloves when handling Sanitizing Solution.

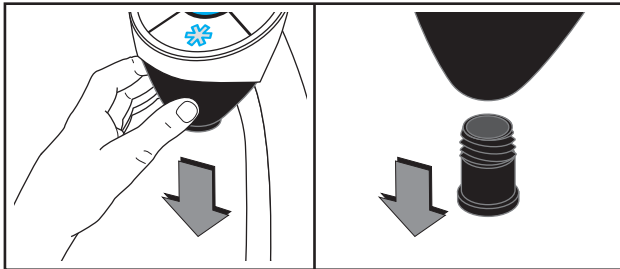

Cleaning Nozzle and Cover

- Fill a small container with Sanitizing Solution.
- Remove Cover by pulling down.
- Unscrew the Nozzle.
- Submerge Nozzle and cover in Sanitizing Solution.
- Soak for a minimum of 4 hours.
- Remove parts from Sanitizing Solution and rinse thoroughly.
- Re-install Nozzle and Cover.
- Wipe external surfaces of Dispensing Head, Drip Tray and countertop with a clean cloth.

CLEANING THE DRIP TRAY

⚠️WARNING Wear protective gloves when handling Sanitizing Solution.

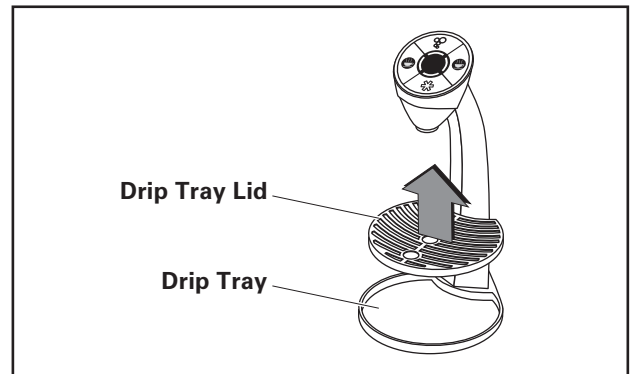

Cleaning the Drip Tray

- Lift Drip Tray Lid from unit.
- Wipe top and bottom of Drip Tray Lid with a clean cloth and Sanitizing Solution.
- Wipe interior of Drip Tray with a clean cloth and Sanitizing Solution.
- Replace Drip Tray Lid.

CLEANING THE COOLING SYSTEM CONDENSER GRILLE

The Cooling System Condenser Grille is located on the front side of the Cooler/Carbonator.

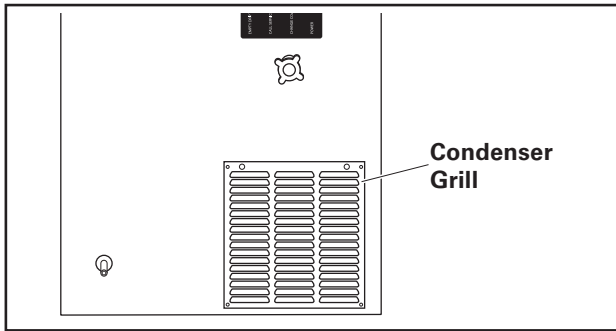

Cooling System Condenser Grille Location

CAUTION Condenser Grille must be kept clean and unobstructed to allow proper cooling of components. Damage to the unit will occur due to overheating!

i IMPORTANT _____
Never cover the Cooling Fins.

i IMPORTANT _____
Never place objects in front of the Cooling Fins.

The Cooling Fins should never be blocked and a minimum distance of 4" to other objects must be maintained.

Clean the Cooling Fins with a suitable brush or vacuum cleaner.

Degrease with a soft cloth sprayed with degreaser.

CAUTION Never spray degreaser or any other liquid into the Condenser Grille.

EXTERIOR CLEANING

Wipe all surfaces with a soft cloth and a non-abrasive cleaner.

i IMPORTANT _____
Never use an abrasive cleaner to clean the unit.

CHANGING THE CO₂ CYLINDER

WARNING Wear protective gloves and safety glasses when changing CO₂ Cylinders.

WARNING CO₂ is a colorless, odorless gas. A danger of suffocation exists when in high concentration. Make sure there is adequate ventilation when exchanging CO₂ Cylinders.

The CO₂ Cylinder can either be located inside the cabinet with the system or outside the in a remote location.

Regardless of location, the Cylinder is fitted with a Regulator that has been preset for proper operation. The Regulator should never be adjusted by the end-user.

To change the CO₂ Cylinder close the Valve on top of the empty Cylinder.

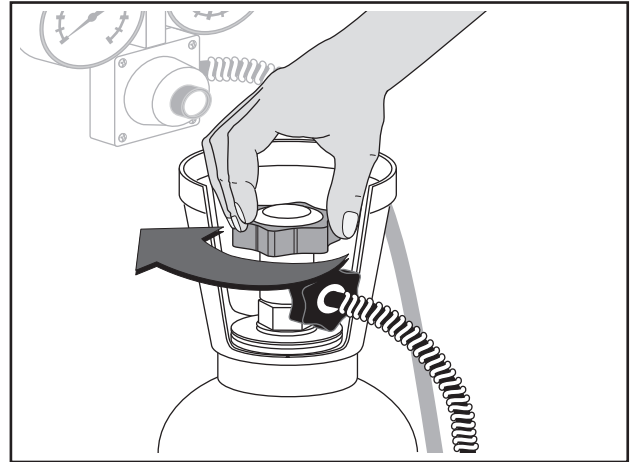

Close Empty Cylinder Valve

Release the line pressure by opening the Sparkling Water Dispenser until no gas escapes.

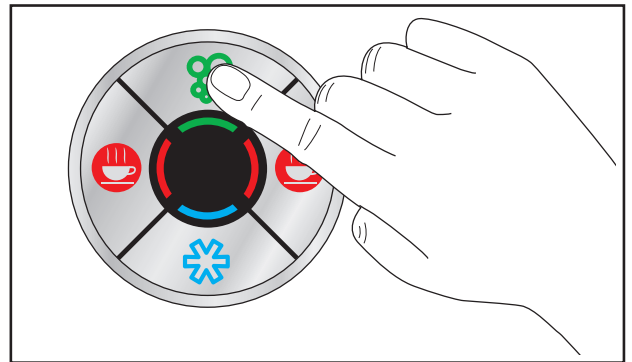

Dispensing Chilled Sparkling Water

Loosen the connection to the Cylinder with the wrench provided and remove the Regulator from the Cylinder.

⚠ WARNING The line is pressurized. Pressure will be released while performing this procedure. Handle carefully.

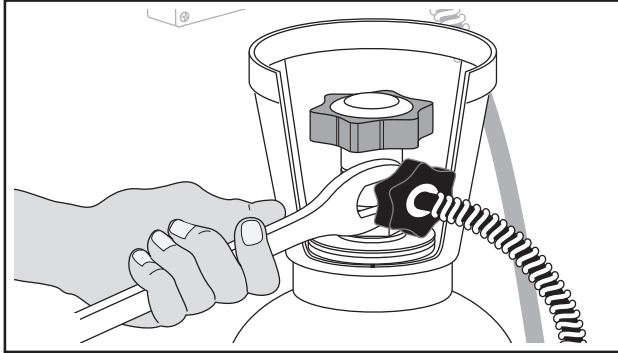

Disconnect High-Pressure Hose

SECURE CYLINDER

Move empty Cylinder to storage area and secure safely.

Remove the plastic plug or tape from the new Cylinder outlet and discard it.

i IMPORTANT _____

To avoid confusion, do not replace plastic plugs in the outlet of empty CO₂ Cylinders.

⚠ WARNING Wear protective gloves and safety glasses when purging Cylinder. Be sure to point the Cylinder outlet away from your body.

Purge the replacement Cylinder by quickly opening and closing the Valve on top to clear any dust or moisture from the outlet.

Connect the High-Pressure Hose or Primary Regulator. Make sure the Sealing Washer is seated correctly.

The Regulator should be hand-tightened to the new Cylinder and then tightened firmly with the wrench provided. **Never over-tighten.**

Open the Valve on top of the Cylinder.

Check for leaks using a solution of soapy water or a commercial equivalent.

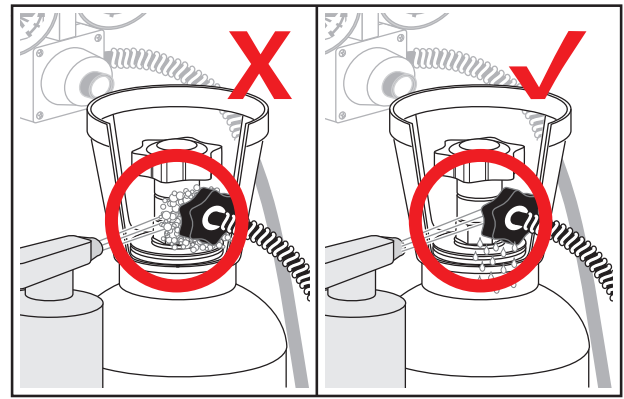

Checking for Leaks

Refer to your local CO₂ supplier for complete handling and safety instructions.

⚠ CAUTION Run all hoses so they cannot be damaged by abrasion or high heat.

STANDING IDLE

Before Long Idle Periods

If the ViTAP Dispensing System will be idle for more than 3 days:

Unplug the Unit.

Close the Water Supply Valve.

Clean the following with antibacterial wipes and disinfectant spray:

- Dispensing Nozzle
- Dispensing Head
- Drip Tray
- Cabinet surfaces

Hang the DO NOT USE sign on the Dispensing Head to ensure the Dispensing System will not be used while the water supply is disconnected.

Cover the Dispensing Head with plastic film.

i IMPORTANT _____

If the Carbonator Pump Protection has switched off the Carbonator Pump, then the unit must be reset. To reset the unit, unplug the Power Cord and plug it back in.

AFTER LONG IDLE PERIODS

⚠️ WARNING Danger to health from a lack of sanitization!

Bacteria and germs can form if the water dispenser has been disconnected from the power supply for longer than 72 hours.

After a longer idle period or a power failure, proceed as follows:

Remove the plastic film from the Dispensing Head.

Clean the following areas with antibacterial cloths and sanitizing spray:

- Dispensing Nozzle
- Dispensing Head
- Drip Tray
- Cabinet surfaces

Plug in the unit.

Open the Water Supply Valve to restore the water to the unit.

Place a suitable container on the Drip Tray.

Rinse the Water Dispenser by running 0.5 gallons of still water.

Rinse the Water Dispenser by running 0.5 gallons of sparkling water.

i IMPORTANT _____

After an idle period of four weeks or more, rinse the water dispenser by running 5.0 gallons of still water and 5.0 gallons of sparkling water.

Remove the DO NOT USE sign.

Unit is ready for normal use.

LEAK PROCEDURES

Leaks in equipment can occur even if all precautions and procedures have been followed properly.

Follow the procedures listed below in the event of a leak.

WATER

Disconnect the Water Dispenser from the power supply.

Disconnect the water supply by closing the Water Supply Valve.

Clean up the leaked water from the area.

Indicate the ViTAP Dispensing System is out of service by hanging a DO NOT USE sign on the Dispensing Head.

Contact **Vivreau Service** Toll-Free at 877-999-1044.

CO₂

Disconnect the Water Dispenser from the power supply.

Close the CO₂ Cylinder Valve.

Open the windows and doors to ventilate the room thoroughly.

Indicate the ViTAP Dispensing System is out of service by hanging a DO NOT USE sign on the Dispensing Head.

Contact **Vivreau Service** Toll-Free at 877-999-1044.

REFRIGERANT

Disconnect the Water Dispenser from the power supply.

Disconnect the Water Supply by closing the Water Supply Valve.

⚠️ WARNING Contact with refrigerant is hazardous to your health! Avoid contact!

Indicate the ViTAP Dispensing System is out of service by hanging a DO NOT USE sign on the Dispensing Head.

Contact **Vivreau Service** Toll-Free at 877-999-1044.

ELECTRIC SHOCK

Disconnect the Water Dispenser from the power supply.

Disconnect the water supply by closing the Water Supply Valve.

⚠️ DANGER Risk of Electrocutation! Unplug equipment or turn off supply circuit breaker immediately.

After removing the immediate danger, Contact **Vivreau Service** Toll-Free at 877-999-1044.

Indicate the ViTAP Dispensing System is out of service by hanging a DO NOT USE sign on the Dispensing Head.

Troubleshooting

The information provided in this section is intended to assist in the basic identification and correction of simple irregularities and malfunctions which might occur during daily operation.

i IMPORTANT _____

Service and repairs must only be performed by properly qualified and trained service personnel.

Always switch off and unplug the equipment before servicing or repairing the unit.

BASIC TROUBLESHOOTING

NO STILL WATER

Check Water Supply Valve is open.

NO SPARKLING WATER

If only gas is coming out, check the main Water Supply or power. If nothing is coming out, check CO₂ Cylinder and change if needed.

LED DISPLAY

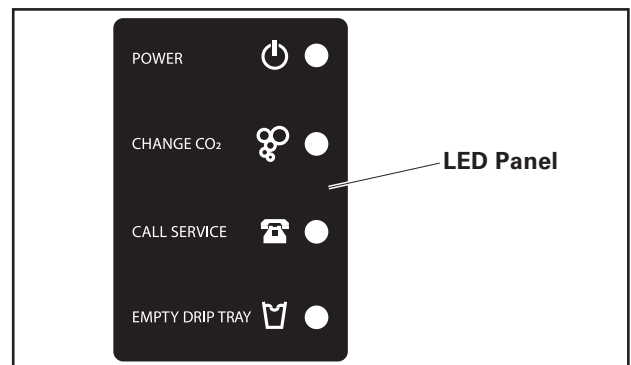

Dispensing Head System LED Display Panel

POWER: Make sure unit is plugged in.

CHANGE CO₂: Replace CO₂ Cylinder.

CALL SERVICE: Unplug unit and check still water.

If still water is not working, check Water Block and water supply. Plug in unit. If Service Light returns call Vivreau Service.

EMPTY DRIP TRAY (Not Activated on this Unit): Empty the Drip Tray waste container.

NO HOT WATER (if equipped with Boiler)

Check that the Power Cord is plugged in and the Power Switch is ON.

WARM WATER (Still and Sparkling)

Make sure Chiller/Carbonator is plugged in and operating.

Make sure the Condenser Grille is not clogged or blocked.

If these Troubleshooting procedures do not resolve the issue, contact **Vivreau Service** Toll-Free at 877-999-1044.



Contact Info

Phone Number:

+1 877 999 1044

Email:

InfoUSA@vivreau.com

InfoCanada@vivreau.com

Or visit vivreauwater.com

VIVREAU[®]
ADVANCED WATER SYSTEMS